



If additional components or add-on items are needed, please contact the retailer you purchased this set from.

Flat Track Hardware Systems General Information and Installation Guide

Thank you for choosing Agave Ironworks Flat Track Hardware

We are thrilled you chose our beautiful, hand-crafted, hardware for your door(s). We know you will love the look, feel, and operation of our products.

To ensure a successful and safe installation of your new hardware, please read the important safety "Warning" below.

Warning: Flat Track Hardware systems can fail, causing serious injury or even death if not installed properly. Flat Track Hardware should be installed and connected through the drywall (or other wall surface) to inner wood framing, beams, headers, and/or other structural parts of the building. Exception: May be installed to outer wood beams, headers, etc. that are part of the existing structure or are securely fastened to inner structural parts.

DO NOT install Flat Track Hardware solely on drywall or other wallboard surface as these surfaces will not support the Track. Every Track mounting screw used in the installation process needs to be securely fastened into a structural surface.

If you have any questions about ensuring a safe installation, consult a professional prior to installation.

Installation Guidelines

Typical Flat Track Hardware Installation

STEP ONE

Flat Track Hardware Components. List of components and quantities found in a typical Flat Track Hardware Kit. Ensure you have the necessary pieces prior to beginning installation:

<u>Component</u>	<u>Quantity</u>
1. Track	1 (in length ordered)
2. Wheel Carriers	2
3. Standoffs	6
4. End Stops	2
5. Anti-Jump Blocks	2
6. Door Bottom stabilizer	2
7. Alternate End Stop Location Kit	1



Components 1 and 2
Wheel Carrier and Track

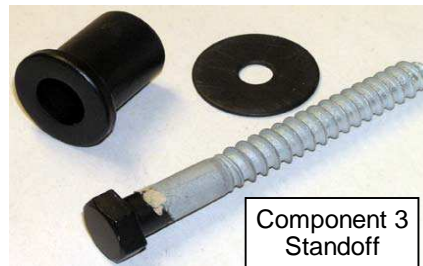

Component 3
Standoff

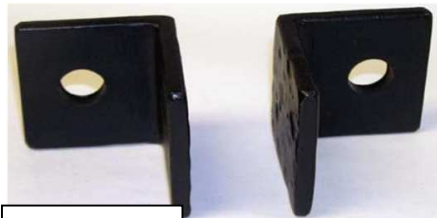

Component 4
End Stops



Component 7
Alternate End Stop

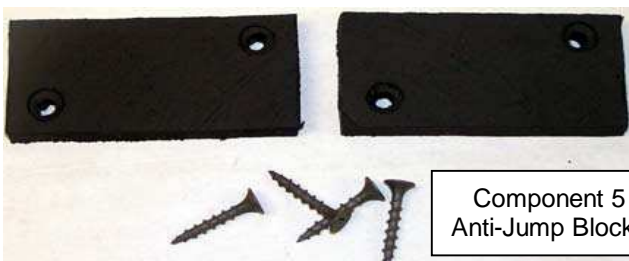

Component 5
Anti-Jump Blocks



Component 6
Door Bottom Stabilizer

STEP TWO

Wall layout and track height

1. Determine vertical height of Track Center (lag screw holes) above doorway by adding the following measurements:

- Gap desired (or needed) underneath door, e.g. 1/2" recommended if Door Bottom Stabilizer is to be used.
- Door height
- 1 3/4" for Wheel Carrier Strap

Example: 1/2" (under door gap) + 72" (door height) + 1 3/4" (Wheel Carrier Strap) = 74 1/4"

Result (based on example): Screw holes for Track Mounting Lag Screws should be 74 1/4" from the floor.

STEP THREE

Drilling screw holes and mounting Track

1. Starting at the floor measure vertically where you want door's edge, when in closed position, X" high (based on your calculations above). Mark the height for your first hole and ensure you are drilling into a structural beam.

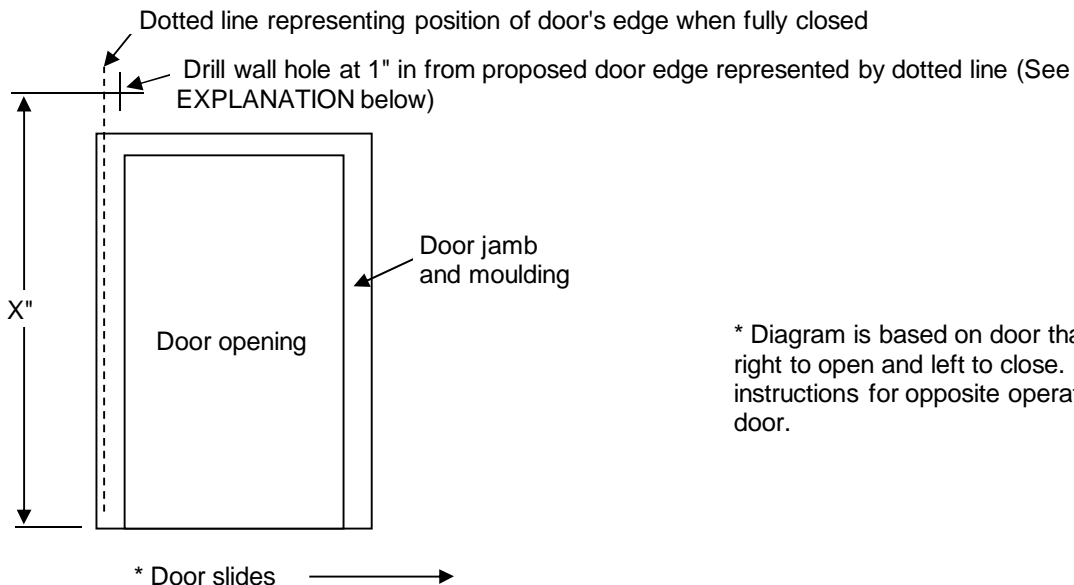

* Diagram is based on door that slides right to open and left to close. Reverse instructions for opposite operation of door.

EXPLANATION - FOR HORIZONTAL LOCATION OF TRACK: Most doors can be mounted so the vertical edge of the door will be even with the extreme vertical edge of the track, when the door is in the fully closed position. Since the first hole is normally 1" from the track ends, simply calculate your horizontal track measurement 1" inward from where YOU WANT the edge of the door to be when in the fully closed position.

STEP FOUR

Completing Track Installation

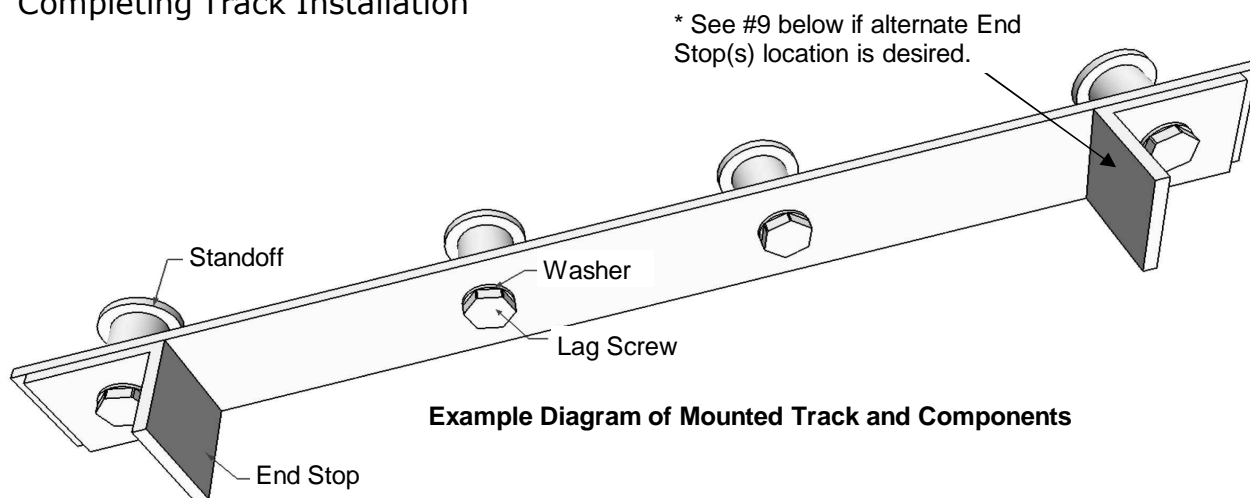

Example Diagram of Mounted Track and Components

INSTRUCTIONS

Attention: Track will stand off the surface 1 3/8". Depending on door thickness, backers or spacers may be required to accommodate casing, trim, etc. and ensure adequate space between the door and those surfaces.

1. Drill your first wall hole using a 3/8" bit for the 1/2" lag screw for the "door closed" end of the track. REMINDER: ALL HOLES MUST BE IN STRUCTURAL BEAMS / SURFACES.
2. Lay the track directly against the wall / mounting surface and insert the first lag screw (without the standoff). Tighten Lag Screw a two or three turns (just enough to hold the track in place for leveling and marking hole at the other end)
3. With the "door closed" end of the track loosely connected by a Lag Screw, prepare to mark a drill location for the track's last hole at the other end.
4. Maneuver your stepstool as necessary toward the "door open" end of the track; push the track against the wall and ensure it is perfectly level and mark the end hole location for drilling. OPTION: Drill through the hole in the track (while holding it level) into your beam or header if you have adequate support and can do so safely.
5. With your second hole drilled, remove the lag screw from the "door closed" end of the track.
6. Mount the track using the Washers, End Stops, Lag Screws and Standoffs at both ends (make sure the Standoffs are mounted with the backplate against the wall / mounting surface, and semi-tighten Lag Screws. IMPORTANT: DO NOT FORGET THE END STOPS PER DIAGRAM ABOVE
7. Check Track's level with both ends screwed in place, and adjust as necessary.
8. One at a time, place the remaining Standoffs behind the remaining holes in the Track. Drill your hole, insert and semi-tighten each of the remaining Lag Screws and Washers. Tighten all screws.
9. * You may mount the End Stop(s) in alternate locations if necessary for functionality. Methods:
 - A. Use one of the other Standoff Locations if appropriate
 - B. Drill a 1/2" Hole at your desired location on the track and use our special End Stop Alternate Location Nut, Bolt, Washers, and Lock Washers for securing.

STEP FIVE

Mounting Pre-Assembled Wheel Carrier Straps to the Door

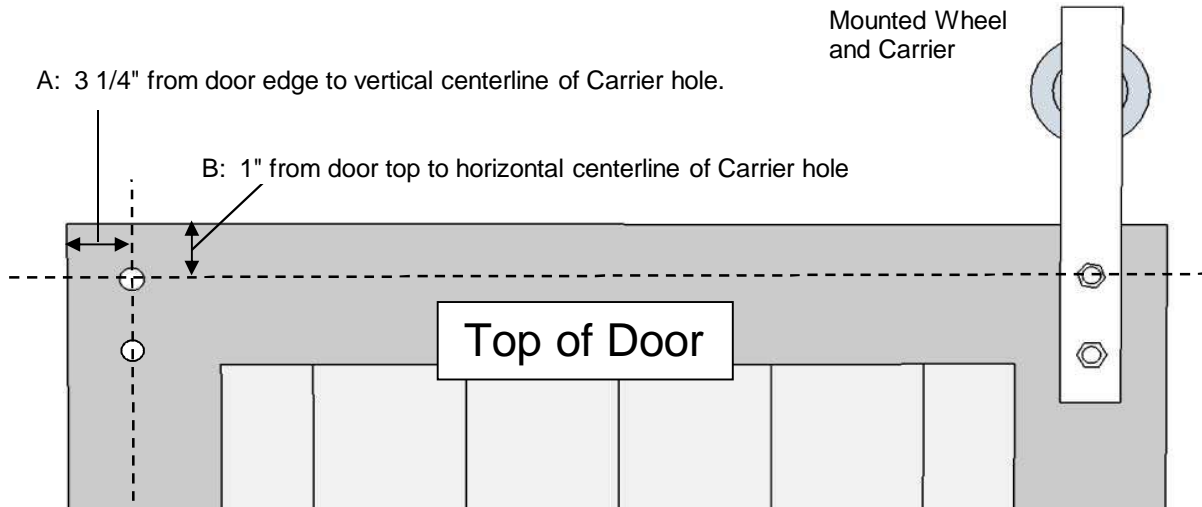

INSTRUCTIONS

ITEMS TO CONSIDER PRIOR TO MOUNTING WHEEL CARRIER STRAPS

Door Bottom Stabilizer: If you plan to router a 1/4" groove in the bottom of the door for the Door Bottom Stabilizer, we suggest you temporarily skip to Step 6 and accomplish that task first. Then return here for installing the Wheel Carrier Straps.

Anti-Jump Blocks: Pre-drilling for the Anti-Jump Block screws will make the Anti-Jump Block installation much easier, since they are installed with the door on the Track. We suggest temporarily skipping to, and reading Step 7. This will help you to understand the Anti-Jump Block installation procedure. Then return here to pre-drill your Anti-Jump Block screw holes and continue with Wheel Carrier installation.

MOUNTING WHEEL CARRIER STRAPS

1. Use a 5/16" drill bit for holes.
2. Measurement "A" above is calculated so the door's edges will be even with the track edges with the door in either the fully open or fully closed position, e.g. touching the end stops. This is the recommended position. You may, however, adjust measurement "A" in either direction by an inch or so if necessary.
3. Measurement "B" above is a critical measurement and should not be changed. The measurement, as indicated, regulates the distance between the top of the door's Anti-Jump Block (included), and the Track, thereby adding a measure of safety to your installation.
4. Use all mounting hardware provided, e.g. bolts, nuts, and washers
5. Once all Wheel Carriers are secure, temporarily mount the door on the track (without the Anti-Jump Blocks) for two purposes:
 - A. To test the function of the track
 - B. To mark locations for installing the Door Bottom Stabilizer(s) if they are being used in your installation (next step).

STEP SIX

Door Bottom Stabilizer Installation

There are two methods for installing Door Bottom Stabilizer(s) -

Method 1: Using a single Door Bottom Stabilizer that fits into a 1/4" routed guide (groove) in your door bottom and holds the door in a vertical position.

Method 2: Using two Door Bottom Stabilizers (one on each side of the door) that serves the same purpose as Method 1. This method can be used when you are unwilling or unable to create an appropriate guide (groove) in the bottom edge of your door.

NOTE: Door bottom stabilizer(s) are recommended for most doors to keep the door from swinging into the opening or against a wall, but are not required or applicable in all installations. Contact us if you have questions.

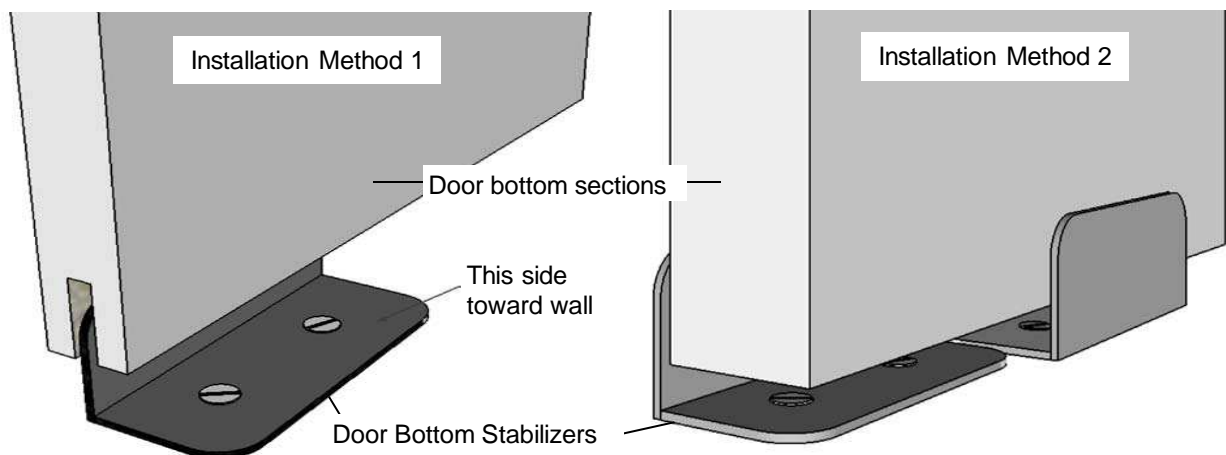

INSTRUCTIONS

1. With the door temporarily hanging on the track (per the final instruction in Step 5) use a level to position the door so it is hanging straight (vertically level).
2. INSTALLATION METHOD 1: Position the Door Bottom Stabilizer as shown (with the door hanging vertically level) and mark your location or distance from the wall / door jamb.
3. INSTALLATION METHOD 2: Position the Door Bottom Stabilizers as shown (with the door hanging vertically level) and mark your location or distances from the wall / door jamb for each piece.
3. LEFT TO RIGHT LOCATION (Both Installation Methods): This location should be about the center of the Track near the outer door jamb. Care should be taken to position the Door Bottom Stabilizer(s) to ensure they are guiding the door through it's full range (End Stop to End Stop).
4. Remove the door from the track, if necessary, and secure the Door Bottom Stabilizers to the floor using the hardware provided. Some floor surfaces, e.g. wood, will only need the supplied Screws, and other surfaces may require installing the supplied Lag Shields to secure the Screws.

INSTALLATION TIP: If you are using Installation Method 2, consider "stick-on" felt or similar soft liner placed on the Door Bottom Stabilizers between the door and the stabilizer for smoother operation and to protect the bottom edge of your door.

STEP SEVEN

Anti-Jump Block Installation

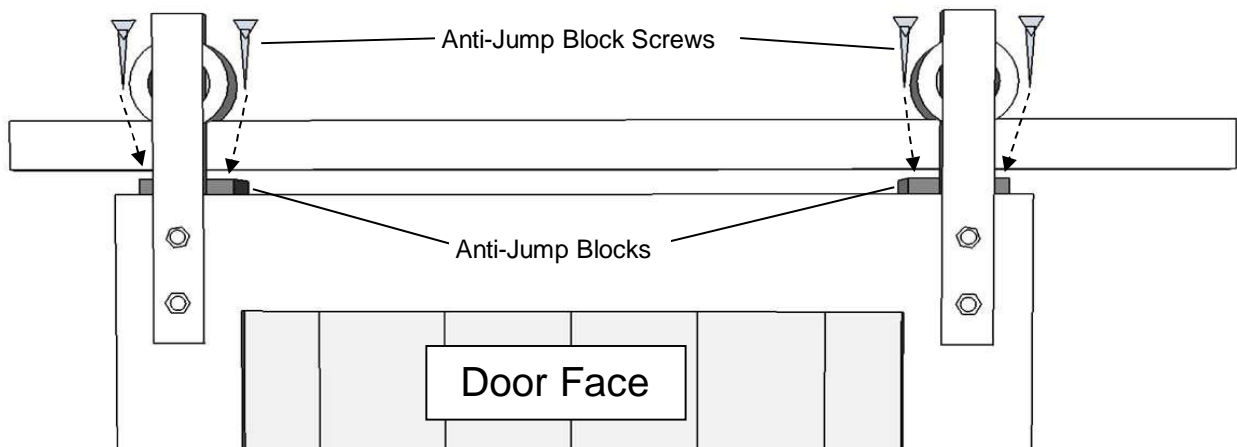

INSTRUCTIONS

1. With the door in place on the Track, slide the Anti-Jump Blocks between the bottom edge of the track and the top edge of the door in the locations as shown above. Place the blocks over your pre-drilled screw holes.
2. Insert and tighten supplied screws.
3. Distance between Track and door top should be about 3/16" or less for maximum safety.

CONGRATULATIONS - YOUR HARDWARE IS INSTALLED